



NX LEAD CRYSTAL BATTERY

MAIN INFORMATION / INFORMATIONS GÉNÉRALES

BRAND	MARQUE	NX
TECHNOLOGY	TECHNOLOGIE	LEAD CRYSTAL
NOMINAL VOLTAGE	TENSION NOMINALE	12V
NOMINAL CAPACITY	CAPACITÉ NOMINALE 25°C	
C120		174Ah
C20		62Ah
C10		150Ah
DIMENSIONS (±2mm)	DIMENSIONS (±2mm)	
• Length / Longueur		484mm
• Width / Largeur		170mm
• Height / Hauteur		241mm
• TOTAL HEIGHT WITH TERMINALS / Hauteur totale (avec cosses)		241mm
WEIGHT (±2%)	POIDS (±2%)	46Kg
POLARITY	POLARITÉ	+ -
TERMINAL	TYPE DE COSSSES	M8-F



TECHNICAL INFORMATION / INFORMATIONS TECHNIQUES

MAX DISCHARGE CURRENT	COURANT DE DÉCHARGE MAX	1700A (5S)
INTERNAL RESISTANCE	RÉSISTANCE INTERNE 25°C	5.5 mΩ
SELF DISCHARGE	AUTO DÉCHARGE	
3 months / 3 mois		95%
6 months / 6 mois		85%
12 months / 12 mois		80%
FLOAT CHARGING VOLTAGE	TENSION DE CHARGE EN FLOATING 25°C	13.5V - 13.6V
CYCLING CHARGING VOLTAGE	TENSION DE CHARGE EN CYCLAGE	14.4V - 14.5V

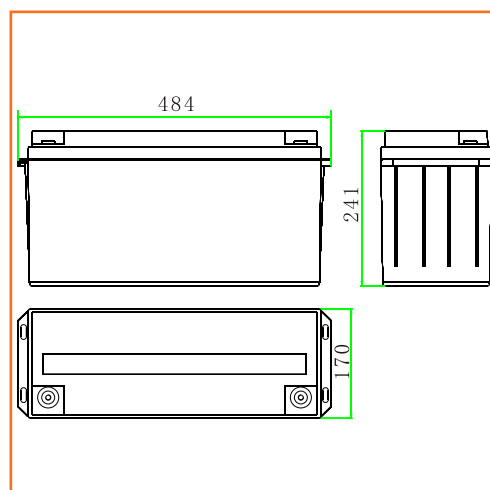

DISCHARGE CURRENT AND CUT OFF VOLTAGE / COURANT DE DECHARGE ET TENSION DE FIN DE DECHARGE

DISCHARGE CURRENT / COURANT DE DÉCHARGE (A)	DISCHARGE CUT OFF VOLTAGE / TENSION DE FIN DE DÉCHARGE (V)
0.01C	11.40
0.01C - 0.05C	11.10
0.05C - 0.1C	10.80
0.1C - 0.5C	10.50
0.5C - 1C	10.20
1C - 3C	9.60
3C - 6C	9.00
6C - 10C	7.80
10C	7.20

CHARGE vs TEMPERATURE

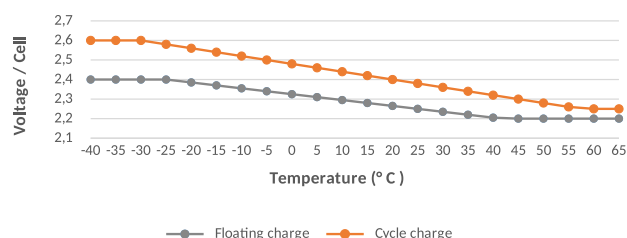

PRODUCT DESCRIPTION / DESCRIPTION DU PRODUIT

UK: Lead Crystal batteries offer significantly better performance than traditional lead acid battery technologies. Totally sealed, Lead Crystal batteries use a new type of electrolyte that crystallizes when charged/discharged. This new electrolyte technology (non-corrosive SiO₂ acid) combined with the use of high quality plates (high-purity lead calcium selenium) considerably improves battery performance.

FR: Les batteries Lead Crystal offrent des performances nettement supérieures aux technologies classiques de batterie plomb. Totalement étanches, les batteries au plomb Crystal utilisent un nouveau type d'électrolyte qui se cristallise au fur et à mesure des cycles. Cette nouvelle technologie d'électrolyte (acide SiO₂ non corrosif) combiné à l'usage de plaques de grande qualité (plomb pur calcium sélénium) permet d'améliorer considérablement les performances des batteries.

FEATURES / CARACTERISTIQUES PRINCIPALES

- Greenest lead acid battery:

Less acid, no cadmium, no antimony. NX lead crystal batteries are up to 99% recyclable and are classified as non-hazardous goods for transport.

- Batterie plomb la plus écologique:

Moins d'acide, pas de cadmium, pas d'antimoine. Les batteries NX Lead Crystal sont recyclables jusqu'à 99 % et sont classées comme marchandises non dangereuses pour le transport.

- Long lifespan: Up to 11 years in floating and 2000 cycles at 50% DOD

- Good recovery from deep Cycle : Lead crystal batteries can be 100% discharged

- Long shelf life / Low self-discharge:

Up to 2 years in storage without refresh charging

- Very short recharge time / Higher availability:

Charge up to 3 time faster than other lead acid battery technologies

- Longue durée de vie : Jusqu'à 11 ans en floating et 2000 cycles à 50% de décharge.

- Performance en décharge profonde: Supporte des profondeurs de décharge jusqu'à 100%

- Faible autodécharge / Longue durée de stockage : Les batteries lead crystal peuvent être stockées jusqu'à 2 ans sans recharge.

- Recharge rapide / Plus grande disponibilité :

Charge jusqu'à 3 fois plus rapide que les autres technologies de batteries au plomb

- Safest Lead Acid Technology:

- Extreme temperature resistance (-40°C to +65°C)
- High resistance to vibration
- Operation in any direction
- Sealed and Maintenance Free

- Technologie Haute fiabilité:

- Bonne résistance aux températures extrêmes (-40°C à +65°C)
- Bonne résistance aux vibrations,
- Fonctionnement dans n'importe quel sens
- Étanche et sans entretien

- High Rate discharge : Excellent high rate discharge

- Décharge rapide : Excellentes performances pour des usages à débit élevé (UPS par exemple)

CAUTION / AVERTISSEMENT

- Operation in any orientation except permanently inverted.

- Continuous use of the battery in a permanently inverted position may adversely affect battery life and performance.

- End-of-life NX batteries must be recycled in accordance with current legislation.

- Fonctionnement dans n'importe quel sens sauf en utilisation inversée continue.

- L'utilisation continue de la batterie en position inversée peut impacter négativement sa durée de vie et ses performances.

- Les batteries NX en fin de vie doivent être recyclées selon la législation en vigueur.

APPLICATIONS / APPLICATIONS

Solar and renewable energies

Leisure (marine, camping car, etc.)

Cyclic use (Mobility scooters, Electric vehicles, Golf carts, etc.)

Medical

Emergency lighting

Railway signal

Alarm and security system

Aircraft signal

Electronic devices and equipment

Emergency backup

Power supply

Solaire et énergies renouvelables

Servitude (marine, camping car, etc...)

Usage cyclique (Fauteuil roulant, Véhicule électrique, Golf etc...)

Médical

Éclairage de secours

Signalisation ferroviaire

Alarme et sécurité

Signal d'avion

Appareils et équipements électroniques

Alimentation de secours

Réserve d'énergie

* Non exhaustive list / Liste non-exhaustive



CONSTANT CURRENT DISCHARGE CHARACTERISTICS / CARACTÉRISTIQUES DE DÉCHARGE À COURANT CONSTANT

Cut off voltage per cell	5min	15min	30min	45min	1h	2h	3h	4h	5h	6h	8h	10h	12h	20h	24h
1.60V	392	236	147	100	90.0	54.0	39.5	31.5	27.3	25.0	19.2	15.9	13.3	8.25	7.06
1.67V	349	223	142	98.0	88.5	52.5	39.0	30.9	26.9	24.4	18.9	15.7	13.2	8.18	7.03
1.70V	313	210	136	96.0	87.0	51.8	38.5	30.5	26.3	23.8	18.8	15.5	13.1	8.06	7.00
1.75V	271	195	132	92.0	84.0	50.3	37.5	30.0	25.5	23.1	18.4	15.3	13.0	7.99	6.88
1.80V	240	182	126	88.0	82.5	48.8	36.8	29.4	24.8	22.5	18.0	15.0	12.9	7.95	6.75
1.83V	216	172	122	86.0	81.0	48.0	35.9	29.1	24.0	22.1	17.6	14.7	12.8	7.76	6.69
1.85V	205	165	119	84.0	79.5	46.9	35.0	28.5	23.3	21.3	17.3	14.5	12.7	7.50	6.56

Units: Amperes (25°C, 77°F)

CONSTANT CURRENT DISCHARGE CHARACTERISTICS / CARACTÉRISTIQUES DE DÉCHARGE À COURANT CONSTANT

Cut off voltage per cell	5min	15min	30min	45min	1h	2h	3h	4h	5h	6h	8h	10h	12h	20h	24h
1.60V	658	420	269	192	174	101	73.2	59.1	51.4	44.2	36.6	30.4	24.9	16.2	13.1
1.67V	572	398	261	187	171	99.8	72.8	58.2	51.1	43.9	36.3	30.2	24.7	16.1	13.0
1.70V	559	386	253	182	170	98.8	72.4	58.0	51.0	43.8	36.1	30.1	24.6	15.9	12.9
1.75V	493	360	247	178	167	97.9	72.0	57.9	50.7	43.6	35.8	29.9	24.4	15.8	12.8
1.80V	433	342	238	173	163	95.9	71.0	57.1	50.5	43.2	35.3	29.6	24.1	15.7	12.7
1.83V	398	329	233	170	159	94.7	69.9	56.6	49.9	42.7	34.9	28.8	24.0	15.4	12.6
1.85V	355	314	220	165	152	93.3	68.4	55.7	49.1	42.0	34.3	28.1	23.9	15.0	12.6

Units: Watts per cell (25°C, 77°F)

CHARGE AND DISCHARGE CURVES / COURBES DE CHARGE ET DÉCHARGE

Temperature and float service life / Température et durée de vie

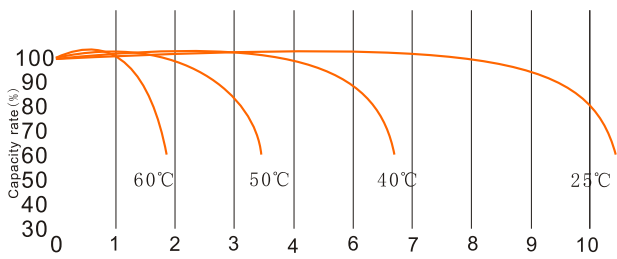

Temperature and discharge capacity / Température et capacité de décharge

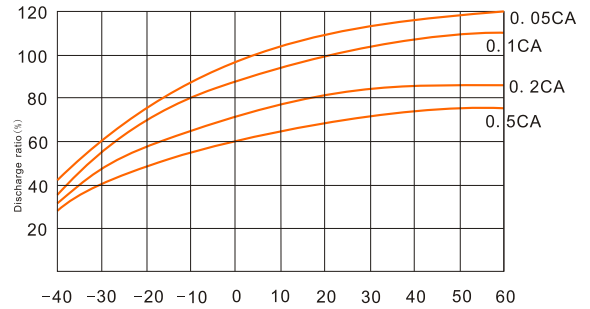

Discharge characteristics 77°F (25°C) / Caractéristiques de décharge 77°F (25°C)

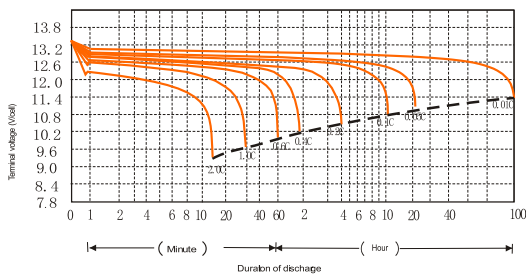

Float service life / Durée de vie en floating

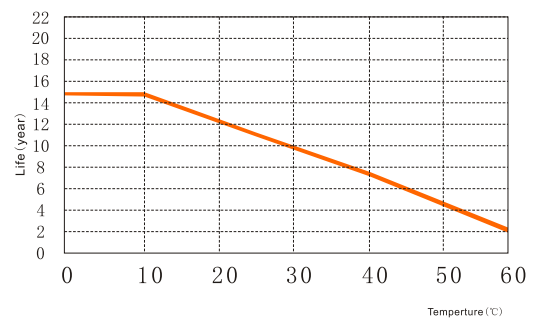

Charge characteristics 77°F (25°C) / Caractéristiques de charge 77°F (25°C)

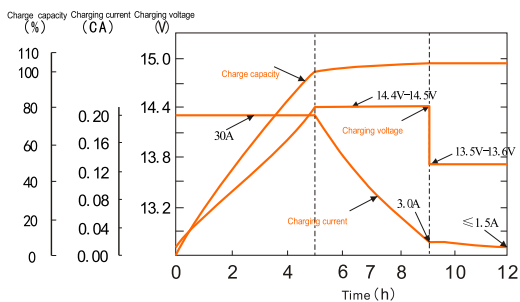

Cycle life curves (25°C) / Courbes de cycle de vie (25°C)
Discharge at 0.1C / Cut off voltage 1.8V by cell

